

Reinforced Concrete Beams Ultimate Strength Design (ACI 318-14) – PART II

- Reinforcement Detailing
- Reinforced Concrete Examples
- 3D-Print Evolution (Video)

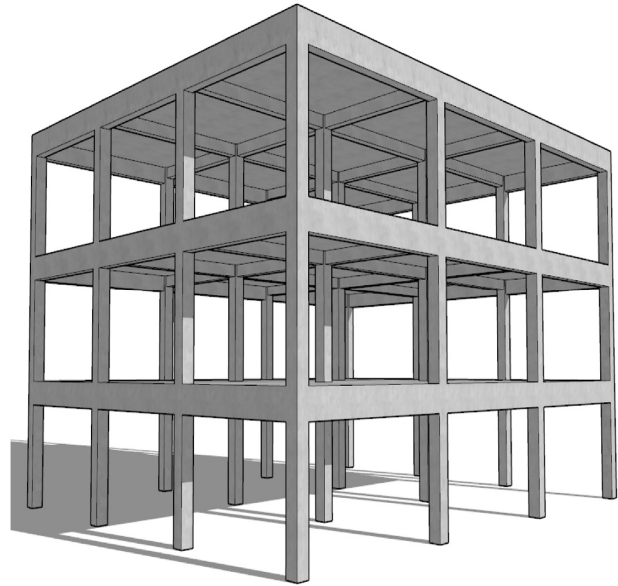

Details of Reinforcement

Size

- Nominal 1/8" increments

Grade

- 40 (40 ksi)
- 60 (60 ksi)
- 75 (75 ksi)

| Bar size designation | Nominal cross section area, sq. in. | Weight, lb per ft | Nominal diameter, in. |
|----------------------|-------------------------------------|-------------------|-----------------------|
| #3 | 0.11 | 0.376 | 0.375 |
| #4 | 0.20 | 0.668 | 0.500 |
| #5 | 0.31 | 1.043 | 0.625 |
| #6 | 0.44 | 1.502 | 0.750 |
| #7 | 0.60 | 2.044 | 0.875 |
| #8 | 0.79 | 2.670 | 1.000 |
| #9 | 1.00 | 3.400 | 1.128 |
| #10 | 1.27 | 4.303 | 1.270 |
| #11 | 1.56 | 5.313 | 1.410 |
| #14 | 2.25 | 7.650 | 1.693 |
| #18 | 4.00 | 13.600 | 2.257 |

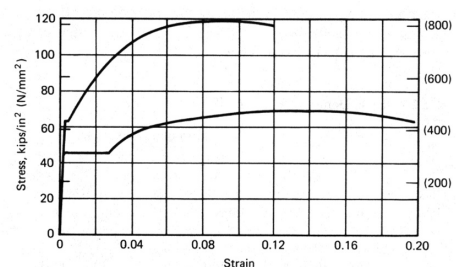

Details of Reinforcement

ACI 318 Chapter 25.2 Placement of Reinforcement

- Cover (ACI 20.6.1)
- Horizontal spacing in beams, s_h (ACI 25.2.1)
1 inch
 d_b
 $4/3 d_{agg,max}$
- Vertical spacing in beams (ACI 25.2.2)
Min 1 inch



<https://www.constructioncost.co/honeycombing-in-concrete.html>

Table 20.6.1.3.1—Specified concrete cover for cast-in-place nonprestressed concrete members

| Concrete exposure | Member | Reinforcement | Specified cover, in. |
|---|---|---|----------------------|
| Cast against and permanently in contact with ground | All | All | 3 |
| Exposed to weather or in contact with ground | All | No. 6 through No. 18 bars | 2 |
| | | No. 5 bar, W31 or D31 wire, and smaller | 1-1/2 |
| Not exposed to weather or in contact with ground | Slabs, joists, and walls | No. 14 and No. 18 bars No. 11 bar and smaller | 1-1/2 3/4 |
| | Beams, columns, pedestals, and tension ties | Primary reinforcement, stirrups, ties, spirals, and hoops | 1-1/2 |

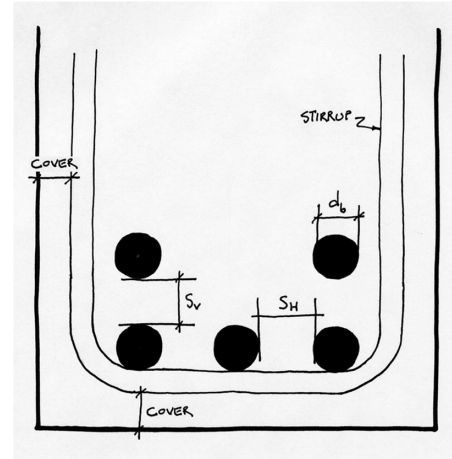

Details of Reinforcement

ACI 318 Chapter 25 Placement of Reinforcement

- Chairs
- Bolsters

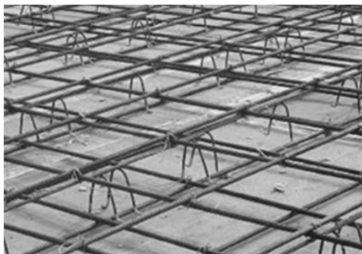

<https://catalog.formtechinc.com>



<http://contractorsupplymagazine.com>

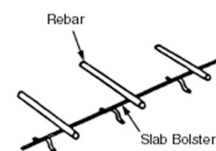
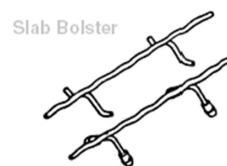
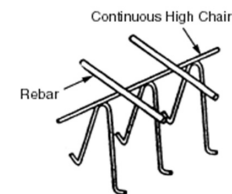
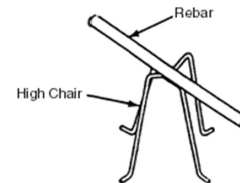
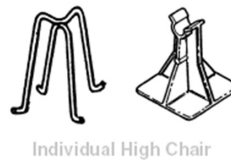
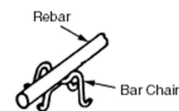

Details of Reinforcement

ACI 318 Chapter 25

Minimum bend diameter

- factor x d_b

Hooks for bars in tension

- ACI Table 25.3.1
- Inside diameter

Bends for stirrups

- ACI Table 25.3.2

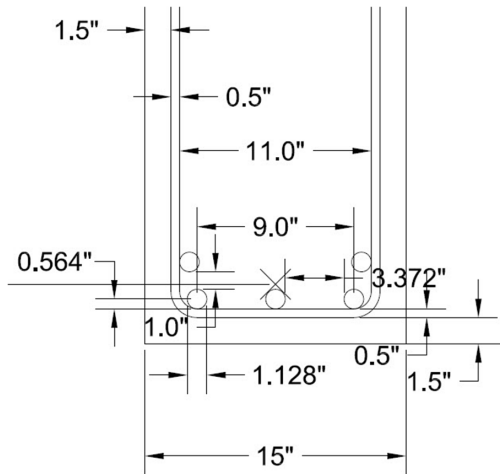

Table 25.3.1—Standard hook geometry for development of deformed bars in tension

| Type of standard hook | Bar size | Minimum inside bend diameter, in. | Straight extension ¹⁾ ℓ_{ext} , in. | Type of standard hook |
|-----------------------|----------------------|-----------------------------------|--|-----------------------|
| 90-degree hook | No. 3 through No. 8 | $6d_b$ | $12d_b$ | |
| | No. 9 through No. 11 | $8d_b$ | | |
| | No. 14 and No. 18 | $10d_b$ | | |
| 180-degree hook | No. 3 through No. 8 | $6d_b$ | Greater of $4d_b$ and 2.5 in. | |
| | No. 9 through No. 11 | $8d_b$ | | |
| | No. 14 and No. 18 | $10d_b$ | | |

¹⁾A standard hook for deformed bars in tension includes the specific inside bend diameter and straight extension length. It shall be permitted to use a longer straight extension at the end of a hook. A longer extension shall not be considered to increase the anchorage capacity of the hook.

Table 25.3.2—Minimum inside bend diameters and standard hook geometry for stirrups, ties, and hoops

| Type of standard hook | Bar size | Minimum inside bend diameter, in. | Straight extension ¹⁾ ℓ_{ext} , in. | Type of standard hook |
|-----------------------|---------------------|-----------------------------------|--|-----------------------|
| 90-degree hook | No. 3 through No. 5 | $4d_b$ | Greater of $6d_b$ and 3 in. | |
| | No. 6 through No. 8 | $6d_b$ | $12d_b$ | |
| 135-degree hook | No. 3 through No. 5 | $4d_b$ | Greater of $6d_b$ and 3 in. | |
| | No. 6 through No. 8 | $6d_b$ | | |
| 180-degree hook | No. 3 through No. 5 | $4d_b$ | Greater of $4d_b$ and 2.5 in. | |
| | No. 6 through No. 8 | $6d_b$ | | |

¹⁾A standard hook for stirrups, ties, and hoops includes the specific inside bend diameter and straight extension length. It shall be permitted to use a longer straight extension at the end of a hook. A longer extension shall not be considered to increase the anchorage capacity of the hook.

Details of Reinforcement

ACI 318 Chapter 25

Development length of bars

- 12" min
- Based on table 25.4.2.2

Table 25.4.2.4—Modification factors for development of deformed bars and deformed wires in tension

| Modification factor | Condition | Value of factor |
|---|--|-----------------------------|
| Lightweight λ | Lightweight concrete | 0.75 |
| | Lightweight concrete, where f_{cr} is specified | In accordance with 19.2.4.3 |
| | Normalweight concrete | 1.0 |
| Epoxy ¹⁾ ψ_e | Epoxy-coated or zinc and epoxy dual-coated reinforcement with clear cover less than $3d_b$ or clear spacing less than $6d_b$ | 1.5 |
| | Epoxy-coated or zinc and epoxy dual-coated reinforcement for all other conditions | 1.2 |
| | Uncoated or zinc-coated (galvanized) reinforcement | 1.0 |
| Size ψ_s | No. 7 and larger bars | 1.0 |
| | No. 6 and smaller bars and deformed wires | 0.8 |
| Casting position ¹⁾ ψ_t | More than 12 in. of fresh concrete placed below horizontal reinforcement | 1.3 |
| | Other | 1.0 |

¹⁾The product $\psi_s \psi_e$ need not exceed 1.7.

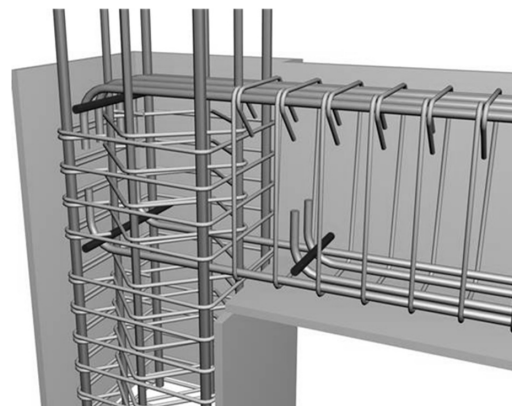

<https://www.buildinghow.com>

Table 25.4.2.2—Development length for deformed bars and deformed wires in tension

| Spacing and cover | No. 6 and smaller bars and deformed wires | No. 7 and larger bars |
|--|---|---|
| Clear spacing of bars or wires being developed or lap spliced not less than d_b , clear cover at least d_b , and stirrups or ties throughout ℓ_d not less than the Code minimum or Clear spacing of bars or wires being developed or lap spliced at least $2d_b$ and clear cover at least d_b | $\left(\frac{f_y \psi_t \psi_e}{25 \lambda \sqrt{f'_c}} \right) d_b$ | $\left(\frac{f_y \psi_t \psi_e}{20 \lambda \sqrt{f'_c}} \right) d_b$ |
| Other cases | $\left(\frac{3 f_y \psi_t \psi_e}{50 \lambda \sqrt{f'_c}} \right) d_b$ | $\left(\frac{3 f_y \psi_t \psi_e}{40 \lambda \sqrt{f'_c}} \right) d_b$ |

Other Useful Tables:

Table A.1 Values of Modulus of Elasticity for Normal-Weight Concrete

| Customary Units | | SI Units | |
|-----------------|----------------|-----------------|----------------|
| f'_c (psi) | E_c (psi) | f'_c (MPa) | E_c (MPa) |
| 3,000 | 3,140,000 | 20.7 | 21 650 |
| 3,500 | 3,390,000 | 24.1 | 23 373 |
| 4,000 | 3,620,000 | 27.6 | 24 959 |
| 4,500 | 3,850,000 | 31.0 | 26 545 |
| 5,000 | 4,050,000 | 34.5 | 27 924 |

Jack C McCormac, 1978, *Design of Reinforced Concrete*.

Table A.2 Designations, Areas, Perimeters, and Weights of Standard Bars

| Bar No. | Customary Units | | | SI Units | | |
|---------|-----------------|--|---------------------|---------------|---|--------------------|
| | Diameter (in.) | Cross-sectional Area (in. ²) | Unit Weight (lb/ft) | Diameter (mm) | Cross-sectional Area (mm ²) | Unit Weight (kg/m) |
| 3 | 0.375 | 0.11 | 0.376 | 9.52 | 71 | 0.560 |
| 4 | 0.500 | 0.20 | 0.668 | 12.70 | 129 | 0.994 |
| 5 | 0.625 | 0.31 | 1.043 | 15.88 | 200 | 1.552 |
| 6 | 0.750 | 0.44 | 1.502 | 19.05 | 284 | 2.235 |
| 7 | 0.875 | 0.60 | 2.044 | 22.22 | 387 | 3.042 |
| 8 | 1.000 | 0.79 | 2.670 | 25.40 | 510 | 3.973 |
| 9 | 1.128 | 1.00 | 3.400 | 28.65 | 645 | 5.060 |
| 10 | 1.270 | 1.27 | 4.303 | 32.26 | 819 | 6.404 |
| 11 | 1.410 | 1.56 | 5.313 | 35.81 | 1006 | 7.907 |
| 14 | 1.693 | 2.25 | 7.650 | 43.00 | 1452 | 11.384 |
| 18 | 2.257 | 4.00 | 13.600 | 57.33 | 2581 | 20.238 |

Table A.4 Areas of Groups of Standard Bars (in.²)

| Bar No. | Number of Bars | | | | | | | | | | | | |
|---------|----------------|-------|-------|-------|-------|-------|-------|-------|-------|-------|-------|-------|-------|
| | 2 | 3 | 4 | 5 | 6 | 7 | 8 | 9 | 10 | 11 | 12 | 13 | 14 |
| 4 | 0.39 | 0.58 | 0.78 | 0.98 | 1.18 | 1.37 | 1.57 | 1.77 | 1.96 | 2.16 | 2.36 | 2.55 | 2.75 |
| 5 | 0.61 | 0.91 | 1.23 | 1.53 | 1.84 | 2.15 | 2.45 | 2.76 | 3.07 | 3.37 | 3.68 | 3.99 | 4.30 |
| 6 | 0.88 | 1.32 | 1.77 | 2.21 | 2.65 | 3.09 | 3.53 | 3.98 | 4.42 | 4.86 | 5.30 | 5.74 | 6.19 |
| 7 | 1.20 | 1.80 | 2.41 | 3.01 | 3.61 | 4.21 | 4.81 | 5.41 | 6.01 | 6.61 | 7.22 | 7.82 | 8.42 |
| 8 | 1.57 | 2.35 | 3.14 | 3.93 | 4.71 | 5.50 | 6.28 | 7.07 | 7.85 | 8.64 | 9.43 | 10.21 | 11.00 |
| 9 | 2.00 | 3.00 | 4.00 | 5.00 | 6.00 | 7.00 | 8.00 | 9.00 | 10.00 | 11.00 | 12.00 | 13.00 | 14.00 |
| 10 | 2.53 | 3.79 | 5.06 | 6.33 | 7.59 | 8.86 | 10.12 | 11.39 | 12.66 | 13.92 | 15.19 | 16.45 | 17.72 |
| 11 | 3.12 | 4.68 | 6.25 | 7.81 | 9.37 | 10.94 | 12.50 | 14.06 | 15.62 | 17.19 | 18.75 | 20.31 | 21.87 |
| 14 | 4.50 | 6.75 | 9.00 | 11.25 | 13.50 | 15.75 | 18.00 | 20.25 | 22.50 | 24.75 | 27.00 | 29.25 | 31.50 |
| 18 | 8.00 | 12.00 | 16.00 | 20.00 | 24.00 | 28.00 | 32.00 | 36.00 | 40.00 | 44.00 | 48.00 | 52.00 | 56.00 |

Ferrocement

- Pioneered by Pier Luigi Nervi
- Dense, small gage reinforcement
- More flexible shapes – no formwork
- Well suited for thin shells
- Less cracking

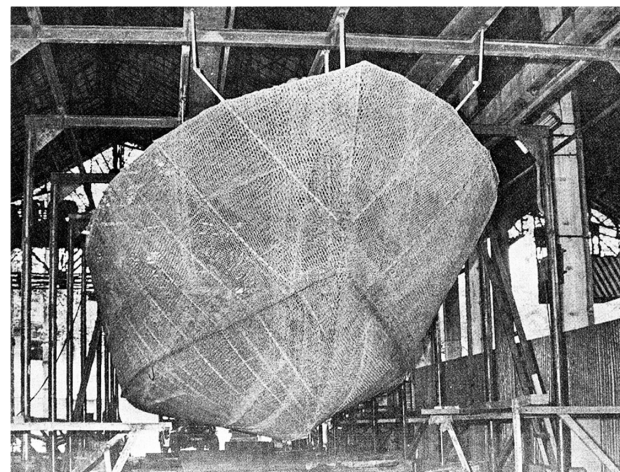
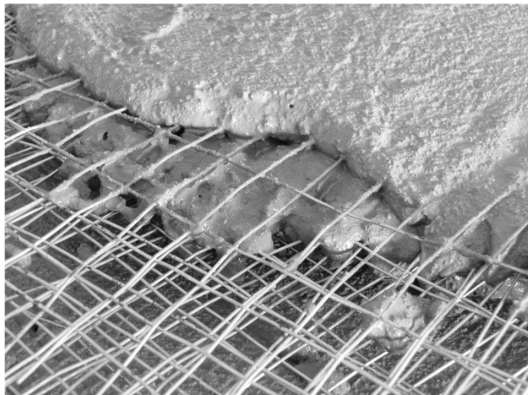
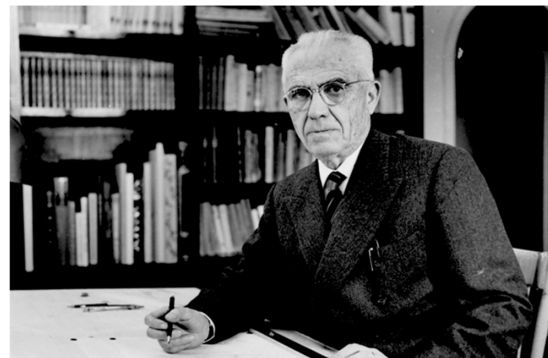

Ferrocement

- Pioneered by Nervi
- Dense, small gage reinforcement
- More flexible shapes – no formwork
- Well suited for thin shells
- Less cracking
- Low-tech applications



Priory Benedictine Church, Missouri, 1956. Architect Gyo Obata



Palazetto dello Sport, Rome, 1957. P.L. Nervi

Fiber Reinforced Concrete

Several different fiber types:

- Steel (SFRC)
- Glass (GFRC)
- Plastic e.g. polypropylene
- Carbon
- Organic e.g. bamboo

Better crack control

Secondary reinforcement

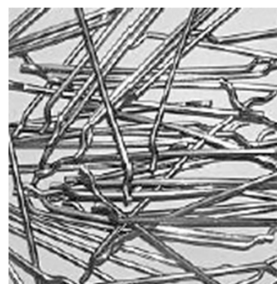
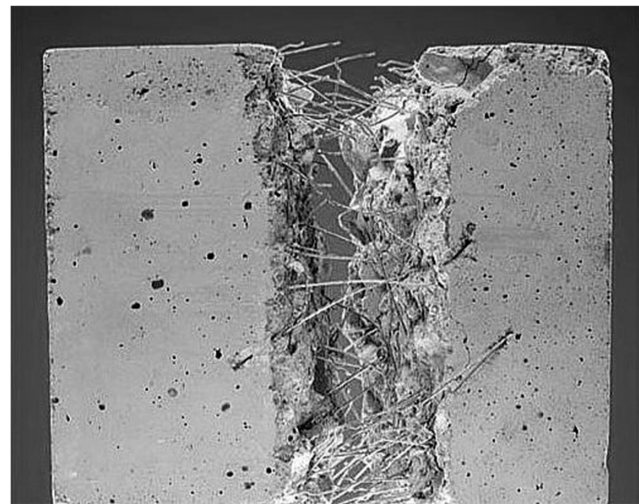

Single



Wave



Bundle

Glass Fiber Reinforced Concrete - GFRC

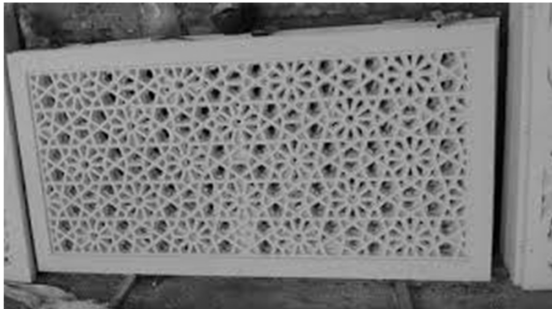

Carbon Fiber

Bamboo



Textile Reinforced Concrete (TRC)

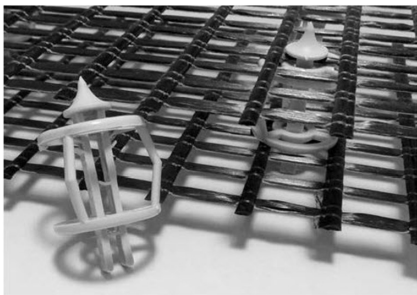
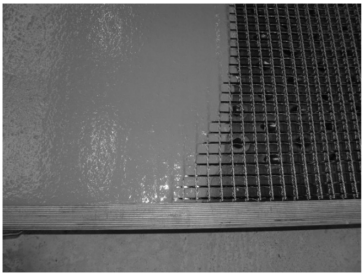
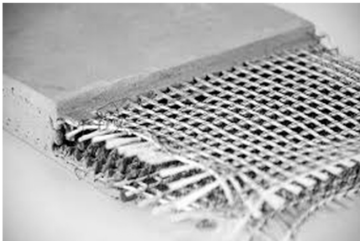

Figure 12: distTEX: special spacers for textile grids [photo: Frank Schladitz, TU Dresden]



Figure 13: Manufacturing of the TRC hyper-shell layer by layer by shotcrete [photo: © RWTH Aachen], [38]



Figure 10: Demolding of a hardened shell element in the concrete yard in Kahla/Saxony [photo: Daniel Ehlig, TU Dresden]

Shotcrete

- Pneumatically applied
- High velocity
- Can include fiber
- Applied to backing
- Reinforced with bars
- Soil stabilization, tunnels

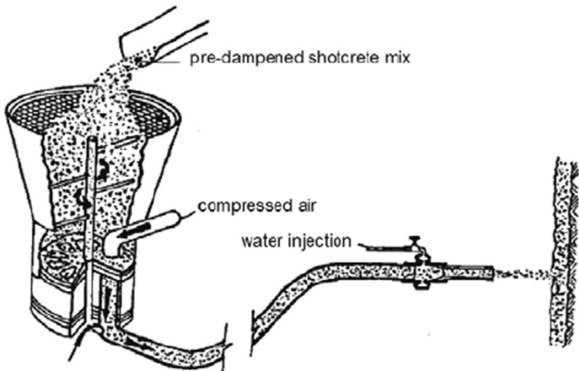

3D-Print Evolution

TED^x Zurich

x = independently organized TED event

THANK YOU

Platinum Partner



Gold Partner



MIGROS
kulturprozent



Silver Partner



Private
Banking

THEPOWEROFTEN

<https://www.youtube.com/watch?v=awpmJriWcEw>