

Introduction to Masonry

- Clay Masonry
- Concrete Masonry
- Autoclaved Aerated Concrete (AAC)

Höchst Entrance Hall, Frankfurt
Arch: Peter Behrens, 1920-24
Photo: Eva Kröcher



Clay Brick

- Molded
or
- Extruded
- Cored – adds stability, strength
cored < 25% > hollow
- Fired (2000° F)
- Sizes – use 3/8" mortar bed
- Six ways to position in wall:

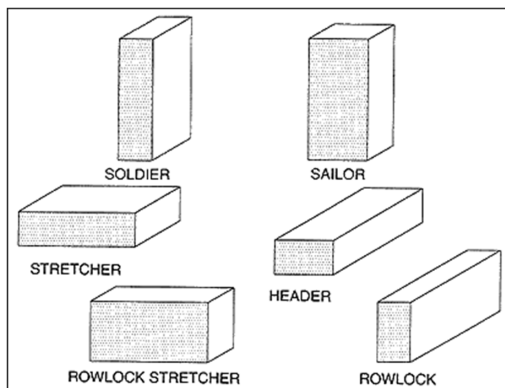
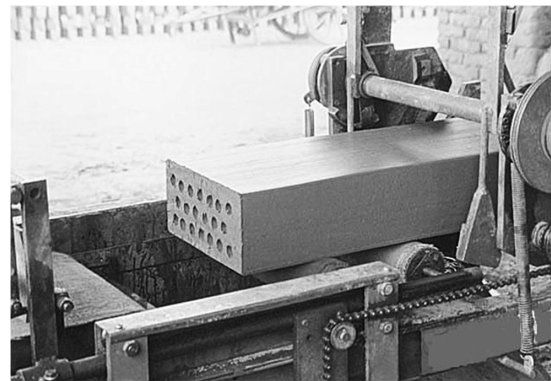

3/8" Mortar Joint Between Bricks (Most Common)

BRICK TYPE	SPECIFIED SIZE D X H X L (INCHES)	NOMINAL SIZE D X H X L	VERTICAL COURSE
Standard	3 5/8 x 2 1/4 x 8	Not modular	3 courses = 6"
Modular	3 5/8 x 2 1/4 x 7 5/8	4 x 2 2/3 x 8	3 courses = 6"
Norman	3 5/8 x 2 1/4 x 11 5/8	4 x 2 2/3 x 12	3 courses = 6"
Roman	3 5/8 x 1 5/8 x 11 5/8	4 x 2 x 12	1 course = 2"
Jumbo	3 5/8 x 2 3/4 x 8	4 x 3 x 8	1 course = 3"
Economy	3 5/8 x 3 5/8 x 7 5/8	4 x 4 x 8	1 course = 4"
Engineer	3 5/8 x 2 13/16 x 7 5/8	4 x 3 1/5 x 8	5 courses = 16"
King	2 3/4 x 2 5/8 x 9 5/8	Not modular	5 courses = 16"
Queen	2 3/4 x 2 3/4 x 7 5/8	Not modular	5 courses = 16"
Utility	3 5/8 x 3 5/8 x 11 5/8	4 x 4 x 12	1 course = 4"

Clay Brick

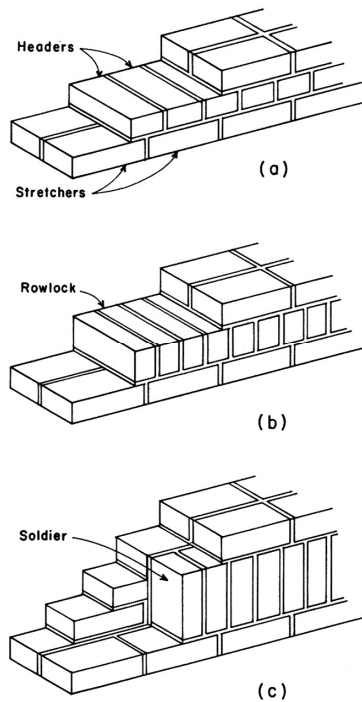
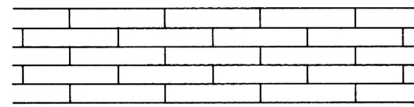
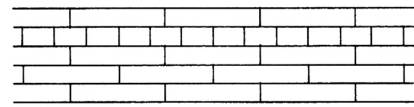

FIGURE 4.2. Ordinary positions for bricks.



running bond



common bond

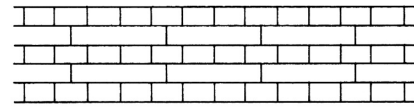

English bond

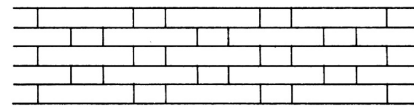

Flemish bond

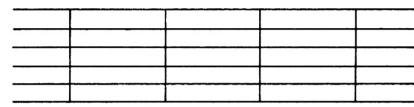

stack bond

Cavity Walls

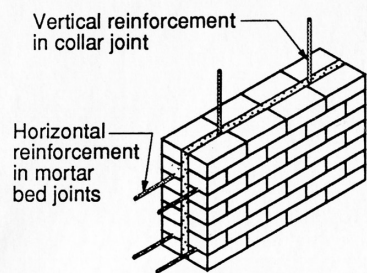

(a) Reinforcement in Joints

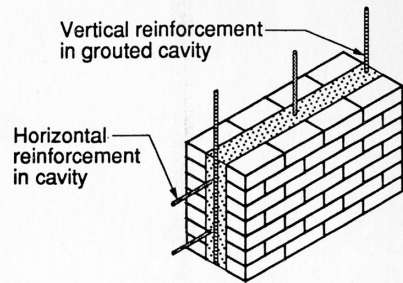

(b) Reinforcement in Cavity

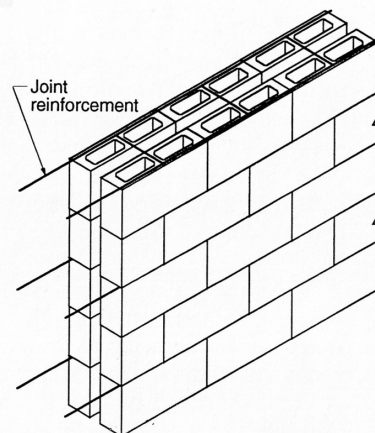
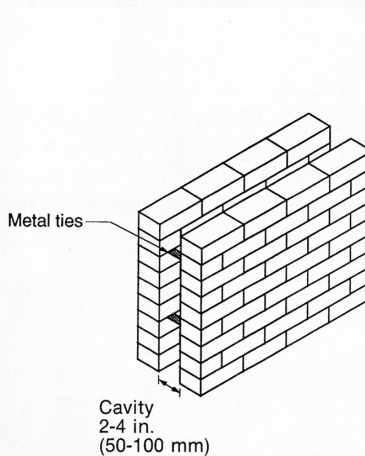

Clay Tile

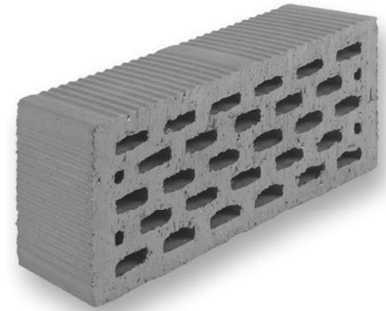
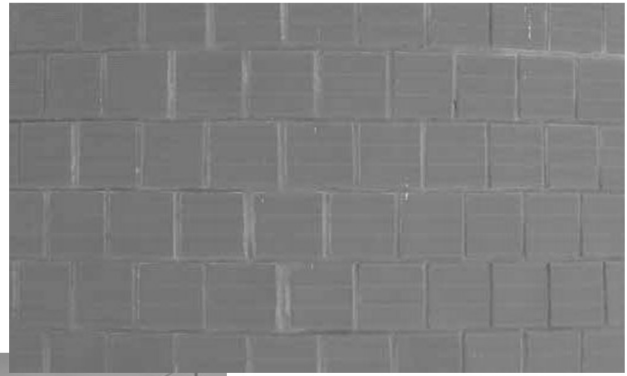
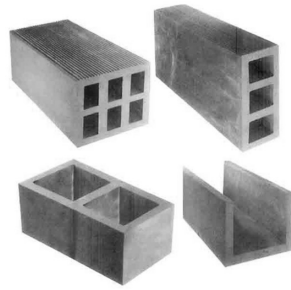

Insulated Clay Tile

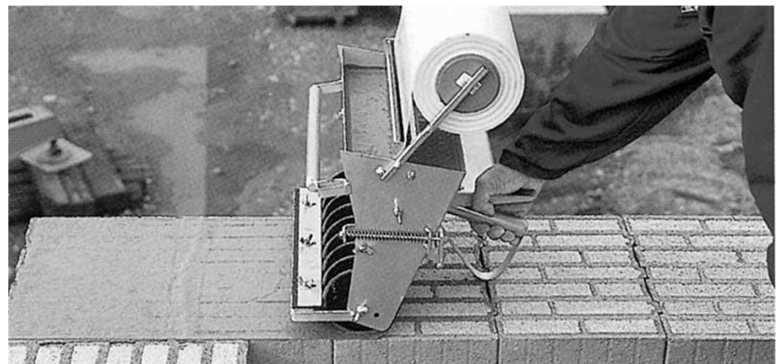
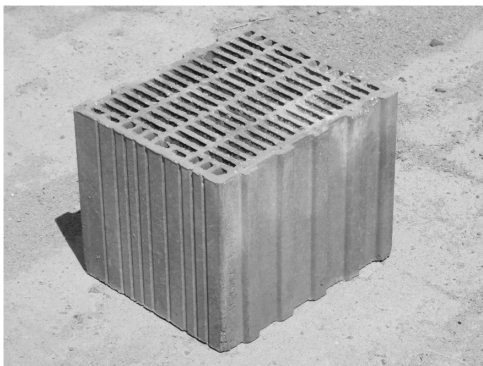

Autoclaved Aeriated Concrete (AAC)

Used predominately in Europe
 Developed by Dr. Johan Axel Eriksson in mid- 1920s in Sweden as "Ytong"
 since 1943, Hebel blocks in Germany
 Current largest production in China



- Lighter weight
- Better insulation value
- Better fire resistance
- Better moisture transmission
- Larger blocks for faster erection
- Can be shaped on site

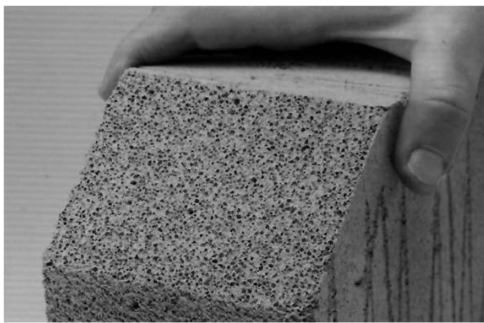

University of Michigan, TCAUP

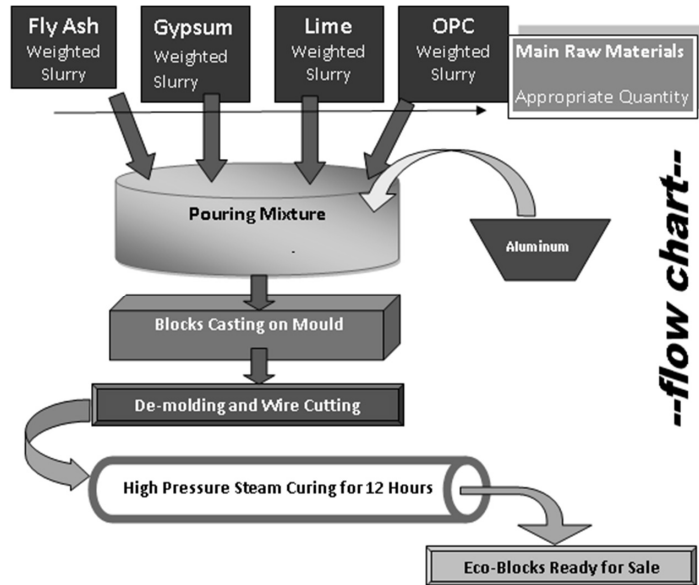

--flow chart--

Structures II

Slide 7 of 22

Autoclaved Aeriated Concrete (AAC)

- Density – 20 to 50 PCF (floats)
- Compressive strength – 300 to 900 PSI
- Allowable Shear Stress – 8 to 22 PSI
- Thermal Resistance - 0.8 to 1.25 R/ IN

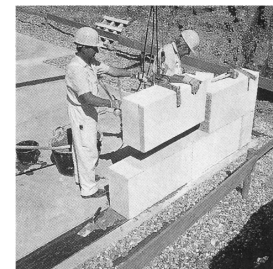
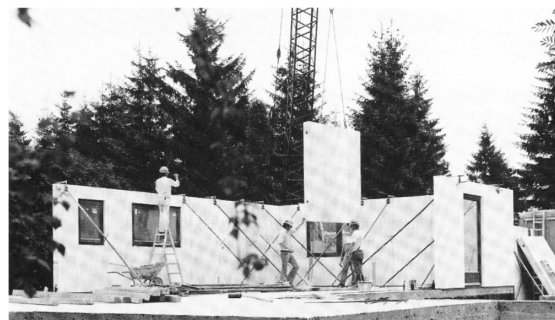
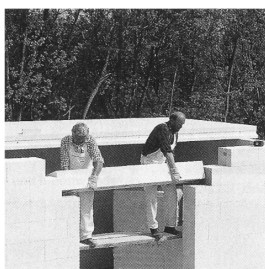

University of Michigan, TCAUP

Structures II

Slide 8 of 22

Autoclaved Aeriated Concrete (AAC)

Easily shaped on site

Thin mortar bed – 1/8" (1mm to 3mm)

Tools for placement (below)

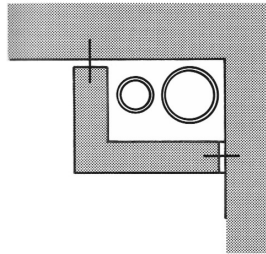
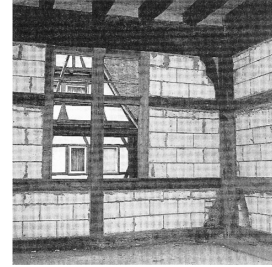
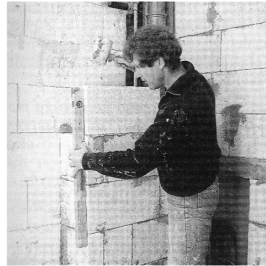
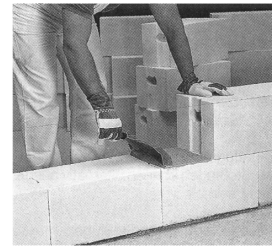
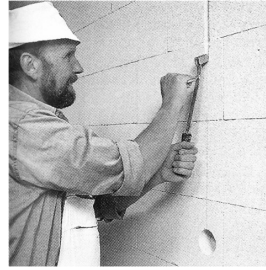
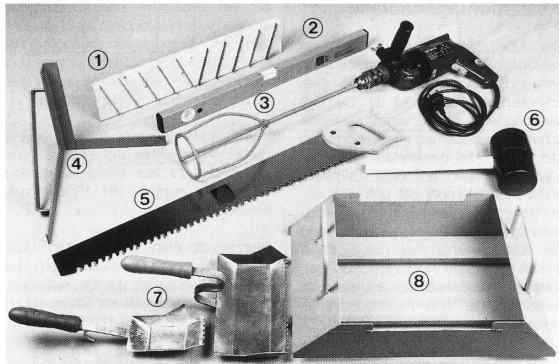

Autoclaved Aeriated Concrete (AAC)

Larger blocks so faster layup – e.g. 8"x8"x24"

Panel layup with onsite crane

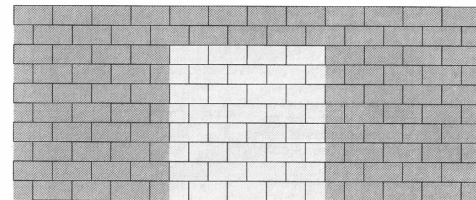
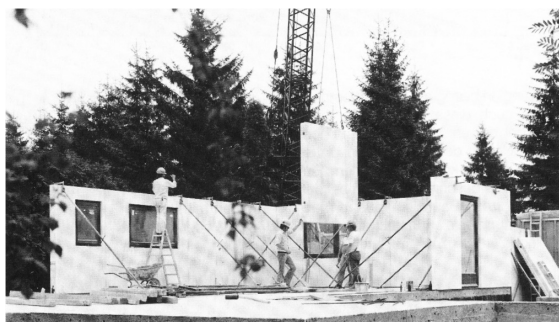
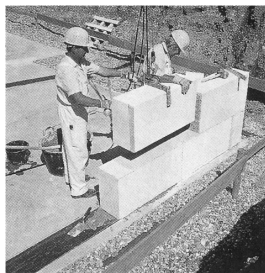

Clay block
32 blocks / m²
9.4" x 4.4"

Konventionelles Mauerwerk:
32 Steine 2 DF/3 DF für 1 m² Wand;
Steinmaß 240 mm x 113 mm x d

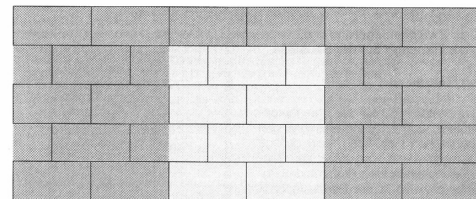

AAC block
8 blocks / m²
19.6" x 9.8"

Porenbeton-Plansteine:
8 Steine pro 1 m² Wand;
Steinmaß 499 mm x 249 mm x d

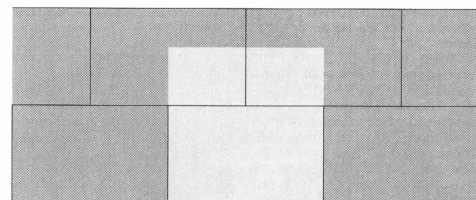

AAC panel
1.6 panels / m²
39.3" x 24.5"

Porenbeton-Planellemente:
1,6 Steine pro 1 m² Wand;
Steinmaß 999 mm x 623 mm x d

Autoclaved Aeriated Concrete (AAC)

Finish with stucco



Abb. 2.4.4-1
Anbringen der Sockelabschluß- und Eckschutzschiene zur Sicherung der Mauerwerkskanten



Abb. 2.4.4-2
Auftrag des Grundputzes von Hand

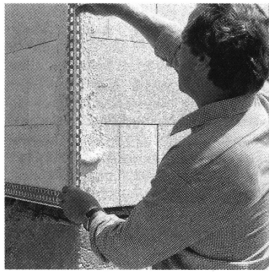

Abb. 2.4.4-3
Auftrag der Deckschicht



Abb. 2.4.4-4
Verreiben der Putzoberfläche mit Filzbrett oder Schwammscheibe



Member Types

Compression members based on proportions.

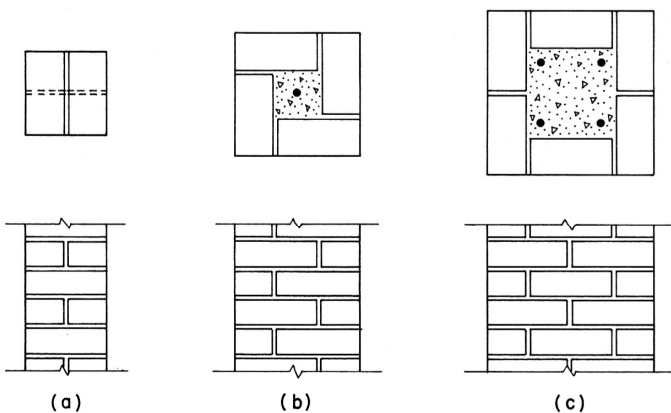
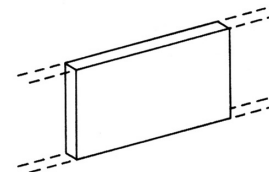
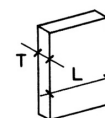

FIGURE 4.12. Forms of brick columns.



(a) Wall



(b) Pier

$$3T < L \leq 6T$$

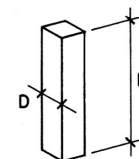

(c) Column

$$H/D \geq 3$$



(d) Pedestal

$$H/D < 3$$

FIGURE 4.6. Classification of vertical compression members.

Concrete Masonry Units (CMU) wall construction



Member Details

Floor / Column details.

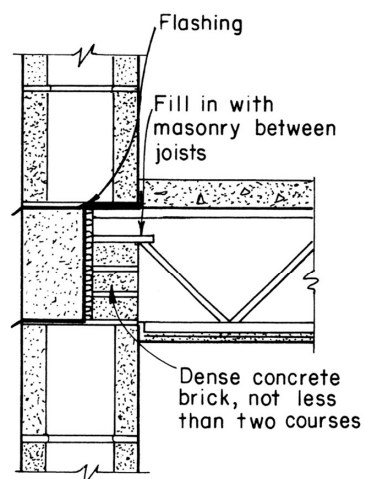

(a) Bar joist floor

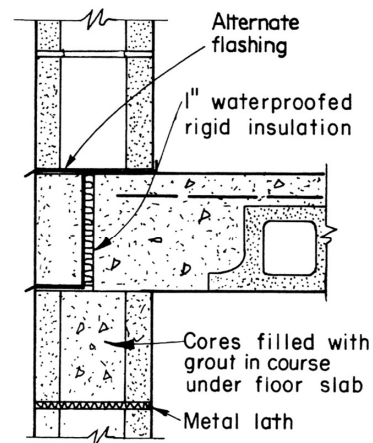

(b) Soffit block joist floor

Concrete Masonry Units (CMU)

- wall sections

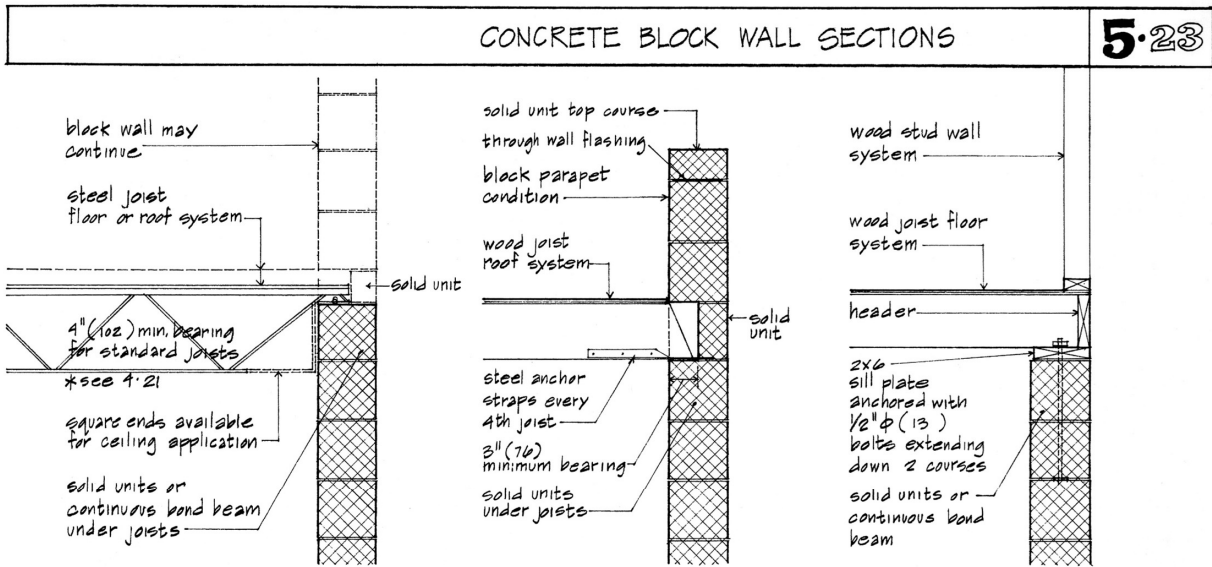

These wall sections are not intended to be complete. They exclude floor, wall, and ceiling finishes, trim, etc. They attempt to illustrate how various floor and roof systems are supported by a concrete block bearing wall. The above-grade wall is literally an extension of the concrete block foundation wall system. Note that the edges of floor and roof planes are not visible from the exterior except at the top of the concrete block wall. All vertical dimensions should be modular, especially if the block is left exposed as the wall finish.

Concrete Masonry Units (CMU)

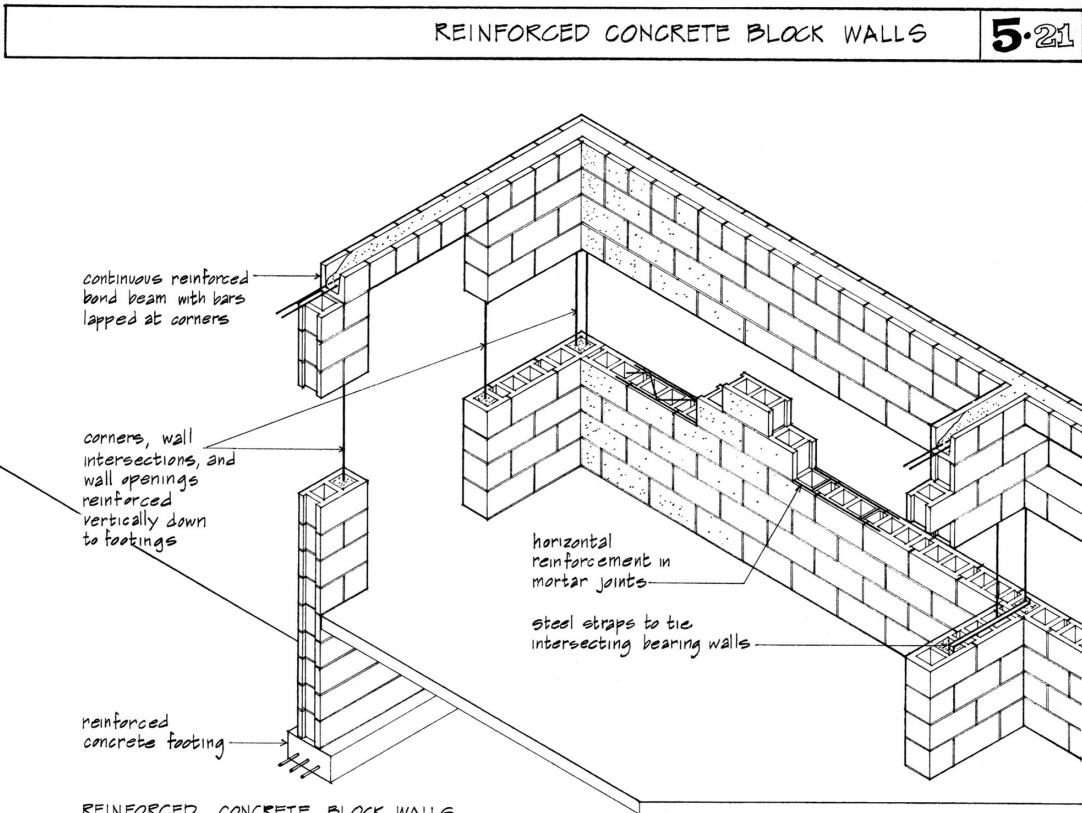

When concrete block walls are subjected to lateral forces such as caused by wind, earth pressure below grade, and earthquakes, they may be reinforced as illustrated above.

Concrete Masonry Units (CMU)

- Cast (molds)
- Dried
- Autoclaved

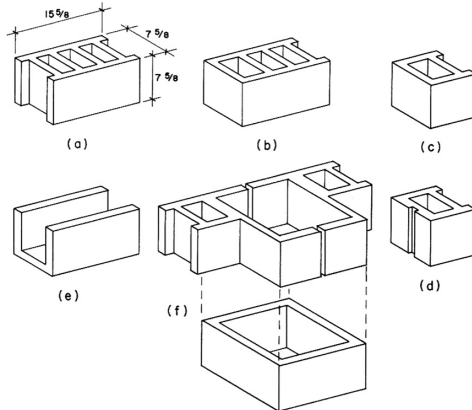
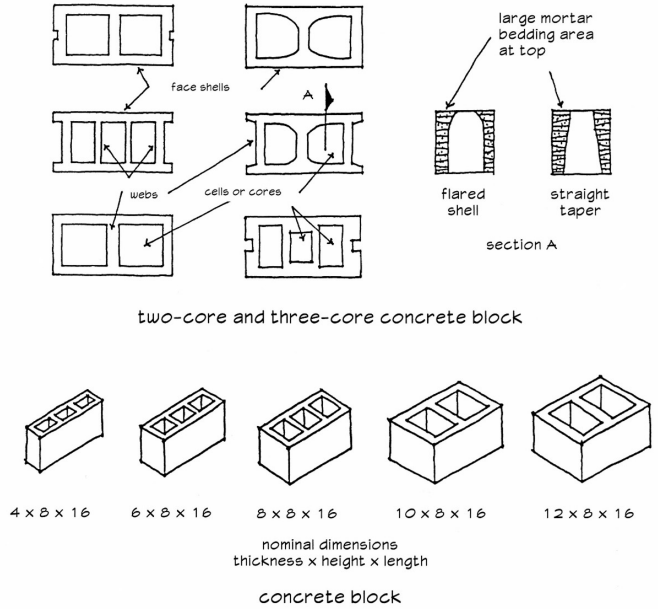

FIGURE 5.1. Forms of CMUs for unreinforced construction.

1.9.1 Standard Concrete Masonry Unit (CMU) Stretchers and Unit Coring



Concrete Masonry Units (CMU)

- Geometric Properties
- NCMA TEK 14-1B
- Radius of gyration, $r = \sqrt{\frac{I}{A}}$

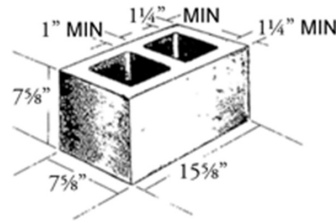

8-inch (203-mm) Single Wythe Walls, 1 1/4 in. (32 mm) Face Shells (standard)

Horizontal Section Properties (Masonry Spanning Vertically)					
Unit	Grout spacing (in.)	Mortar bedding	Net cross-sectional properties ^A		
			A_n (in. ² /ft)	I_n (in. ⁴ /ft)	S_n (in. ³ /ft)
Hollow	No grout	Face shell	30.0	308.7	81.0
Hollow	No grout	Full	41.5	334.0	87.6
100% solid/solidly grouted			91.5	443.3	116.3
Hollow	16	Face shell	62.0	378.6	99.3
Hollow	24	Face shell	51.3	355.3	93.2
Hollow	32	Face shell	46.0	343.7	90.1
Hollow	40	Face shell	42.8	336.7	88.3
Hollow	48	Face shell	40.7	332.0	87.1
Hollow	72	Face shell	37.1	324.3	85.0
Hollow	96	Face shell	35.3	320.4	84.0
Hollow	120	Face shell	34.3	318.0	83.4

Concrete Masonry Units (CMU)

- Reinforcing

Joint Reinforcing



Truss Type



Ladder Type

4.5 Horizontal reinforcement required for masonry not laid in running bond of $0.00028A_g$, placed at a maximum spacing of 48 in. o.c. in horizontal mortar joints or in bond beams.

$$0.00028(7.625)(16) = 0.034\text{in}^2 \quad \text{Use 9 gage (W1.7) at 16 in. o.c.}$$

W1.7 wire
dia. = 0.147 in
area = 0.017 in²
2x wire = 0.034 in²

Rebar Positioners



Placed in mortar joints

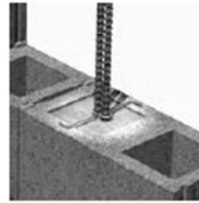

Concrete Masonry Units



Placed in cells



8

Concrete Masonry Construction

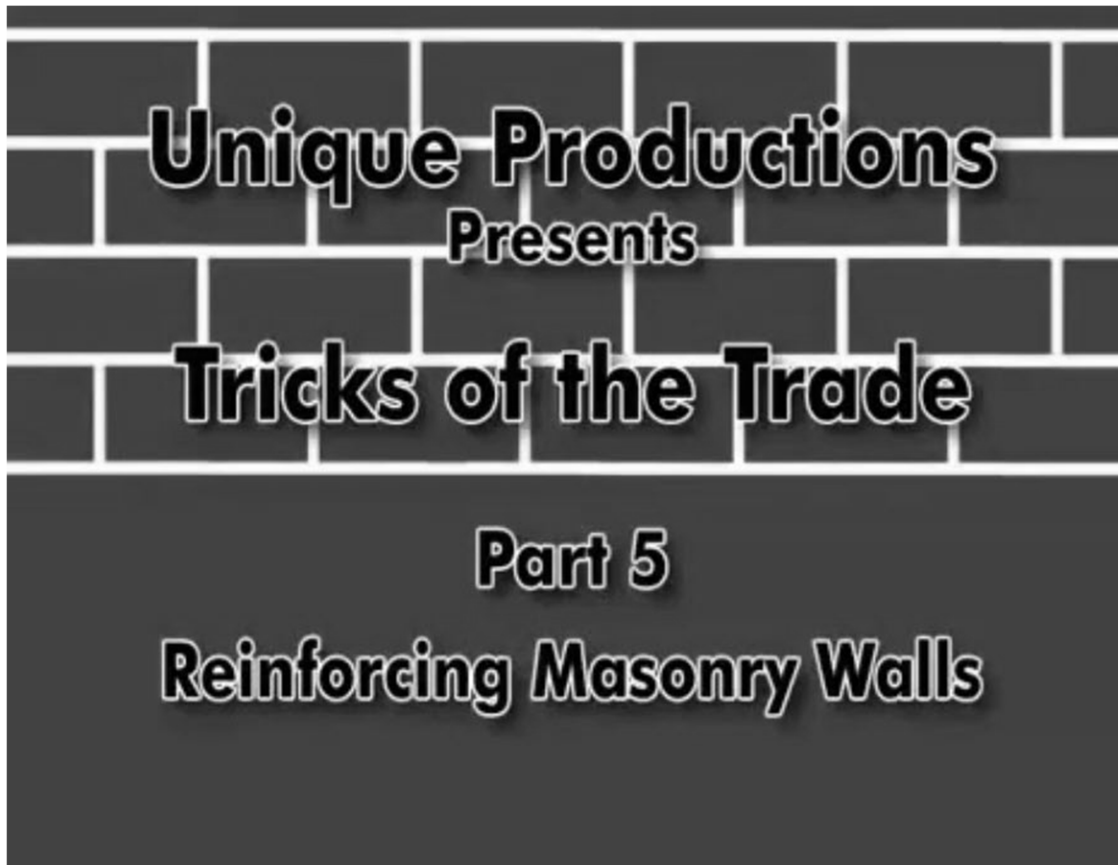

Mortar Types

Types M, S, N, O

The following mortar designations took effect in the mid-1950's:

M **a** **S** **o** **N** **w** **O** **r** **K**
 strongest weakest



Table 2-3. Guide to the Selection of Mortar Type*

Location	Building segment	Mortar type	
		Recommended	Alternative
Exterior, above grade	Load-bearing walls	N	S or M
	Non-load-bearing walls	O**	N or S
	Parapet walls	N	S
Exterior, at or below grade	Foundation walls, retaining walls, manholes, sewers, pavements, walks, and patios	S†	M or N†
Interior	Load-bearing walls	N	S or M
	Non-load-bearing partitions	O	N

*Adapted from ASTM C270. This table does not provide for specialized mortar uses, such as chimney, reinforced masonry, and acid-resistant mortars.
 **Type O mortar is recommended for use where the masonry is unlikely to be frozen when saturated or unlikely to be subjected to high winds or other significant lateral loads. Type N or S mortar should be used in other cases.
 †Masonry exposed to weather in a nominally horizontal surface is extremely vulnerable to weathering. Mortar for such masonry should be selected with due caution.
 Note: For tuckpointing mortar, see "Tuckpointing," Chapter 9.

Relative Parts by Volume

mortar type	Portland cement	lime	sand
M	1	1/4	3 1/2
S	1	1/2	4 1/2
N	1	1	6
O	1	2	9

sum should equal 1/3 of sand volume
 (assuming that sand has void ratio of 1 in 3)

Mortar Types

Type M, S, N, O

Slump is higher than cast concrete based on workability

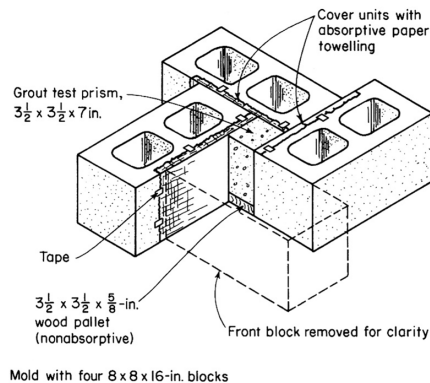

Fig. 2-29. ASTM C1019 method of using masonry units to form a prism for compression-testing of masonry grout.

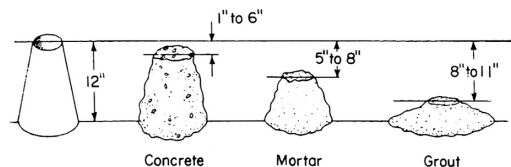

Fig. 2-27. Slump test comparison of concrete, mortar, and masonry grout.